

PROCESSING GUIDE



# Injection Molding



## Table of Contents

Introduction	2
General Process Preparation	2
Handling	2
Drying	2
Regrind	3
Thermal Stability	3
Rheology and Processability	3
Purging	4
Machine Design	5
Materials of Construction	5
Barrel Heating	5
Barrel Capacity	5
Nozzles and Shut-off Systems	6
Clamping Pressure	6
Screws	6
Mould Design	7
Materials of Construction	7
Venting	7
Heating	7
Sprues	8
Gating	8
Hot Runners	8
Machine Settings	8
Temperature Settings	8
Screw Speed	9
Back Pressure	9
Injection Pressure	9
Holding Pressure	9
Shrinkage	9
Tolerances	10
Metal Inserts	10
Cooling Time / Cycle Time	10
Process Simulation	10
Advanced Moulding Technologies	11
Troubleshooting	12

In today's competitive world, you want more from an advanced materials supplier than simply materials. Getting the most from high-performance polymers means considering component design hand-in-hand with material selection and optimised processing. This is the key to maximising an application's value in-use and achieving high manufacturing efficiencies at the lowest possible component cost. With design and material selection decided, processing optimisation becomes critical to drive your product quality and manufacturing yields higher.

With more than 30 years' experience, Victrex Polymer Solutions is uniquely placed to help customers get the very most from polyaryletherketone (PAEK) polymers and products. We offer a wide variety of VICTREX PEEK products that provide exceptional performance over a broad range of temperatures and extreme conditions. Each can be easily processed on standard equipment.

We are able to offer our customers an unrivalled technical capability encompassing design, material selection and processing support for polyaryletherketones. As part of this, we've created this guide to help you optimise your injection moulding processing conditions. In addition, our technical teams located around the world can assist you with prototyping, application development, design and simulation as well as support for metal replacement opportunities.

Our increasing number of Technical Centres have processing equipment to support trials for the full range of VICTREX PEEK products, offer hands-on processing training and extensive materials analysis and characterisation capabilities. We can offer bespoke data generation for specific application programs and our resources are backed up by extensive product and application-based datasets which are continually expanding. We are also involved in a number of industry-leading research projects with academic institutions to further extend our knowledge and help us develop more creative solutions with our customers.

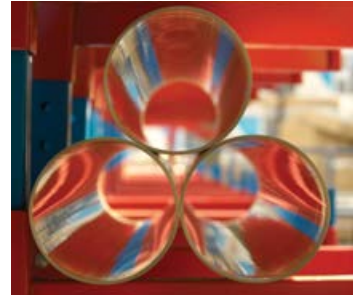

VICTREX® PEEK polymer, along with its higher-temperature variants, VICTREX® HT™ polymer and VICTREX® ST™ polymer, is widely regarded as one of the highest performing thermoplastics in the world. Products are available as melt filtered granules, milled fine powders, or compounds containing a variety of functional fillers and reinforcements. They are used in the design and manufacture of high performance applications to replace metals and other materials to improve performance, increase design freedom and reduce system costs.



VICTREX® PEEK FILM TECHNOLOGY

Victrex APTIV® film provides all of the properties of VICTREX PEEK polymer in a thin, flexible format. The extensive range of properties which includes thermoformability and excellent acoustic performance makes it the highest performing, most versatile thermoplastic film available. APTIV films are a technology enabler to facilitate reduced system costs and improved product performance whilst providing increased design freedom and ease of processing.



VICTREX® PEEK COATING TECHNOLOGY

VICOTE® Coatings are a dedicated range of eco-friendly high performance coatings made from VICTREX PEEK polymers. The powder and aqueous dispersions provide high temperature performance, exceptional scratch and wear resistance, high strength and durability. When compared with traditional coatings, these coatings can be considered to improve performance, extend application life, facilitate design freedom and reduce system costs.



HIGH PERFORMANCE PEEK TECHNOLOGY

VICTREX Pipes™ are durable, lightweight pipe and tube extruded from VICTREX PEEK polymer which offer high temperature performance and a unique combination of properties. An excellent alternative to metals and lower performing polymers, VICTREX Pipes provide chemical and corrosion resistance, low permeability, wear abrasion and impact resistance in a polymer-based pipe and tube.

### High Temperature Performance

Excellent high temperature resistance, with continuous use temperatures of 260°C, which can offer longer life, reliability and increased safety margins in harsh environments.

### Mechanical Strength and Dimensional Stability

Excellent strength, stiffness, long term creep and fatigue properties of Victrex materials allow parts to be designed with reduced weight, greater durability or strength.

### Wear Resistance

In wet or dry abrasive environments, a low coefficient of friction and excellent wear resistance can help maintain part life and integrity.

### Chemical Resistance

Resists corrosion even at elevated temperatures thanks to its ability to withstand a wide range of acids, bases, hydrocarbons and organic solvents.

### Hydrolysis Resistance

Victrex materials have been used successfully to increase component reliability because it does not hydrolyse in water, steam or sea water even at elevated temperatures due to its low moisture absorption and low permeability.

### Electrical Performance

Excellent electrical properties maintained over a wide frequency and temperature range to meet demanding electrical and electronic engineering needs.

### Low Smoke and Toxic Gas Emission

Inherently self extinguishing without the use of additives and has low toxicity of combustion gases.

### Purity

Offers exceptionally low outgassing and extractables for cleaner manufacturing.

### Environmentally Friendly

Fully recyclable, halogen free, RoHS and REACH compliant.

### Quality and Supply Security

All manufacturing is under ISO 9001:2008 registration and EU safety and environmental legislation. Our rigorous attention to detail – we perform over 50 tests on each batch of polymer – assures our customers of product quality and consistency.

As the only vertically-integrated polyketone solutions provider in the world, we have complete control over our key raw material – essential for consistent polymer quality.

Our policy to invest in capacity ahead of demand means that we have an unrivalled capability to assure customers of supply security. Our two independently-operated polymer plants are capable of up to 4,250 tonnes per year. We can also offer fast delivery – typically within 7 days – anywhere in the world through our centralised logistics system and local distribution warehouses.

## INTRODUCTION

Victrex materials are linear aromatic semi-crystalline thermoplastics. They are widely regarded as being the highest performing materials capable of being processed on conventional thermoplastic processing equipment. All general moulding guidelines applicable to semi-crystalline polymers also apply to injection moulding Victrex materials. The higher melting points of Victrex materials require special attention in some areas, which are briefly summarised below.

### Temperature capability:

The plasticising unit must be able to operate controllably up to 400°C for processing PEEK, and up to 430°C for processing HT and ST. A minimum tool surface temperature of 170°C must be reached to obtain parts at standard level of crystallinity with expected material performance.

### Moisture content:

Although not hygroscopic, Victrex materials must be dried prior to moulding.

### Cleanliness:

Contamination must be avoided - dedicated scoops and trays for drying etc. are strongly recommended.

### Gates and runners:

These are larger than those used for moulding other engineering or high performance polymers.

Details of this high level summary are addressed in subsequent sections. Part design is outside the scope of this document, but standard polymer design guidelines apply to Victrex materials as they do to any other thermoplastic. For design support from our technical team, please contact your local Victrex representative.

## GENERAL PROCESS PREPARATION

### HANDLING

Victrex materials are supplied in a sealed polyethylene bag inside a heavy-duty cardboard box or in bulk in palletised octoboxes. It is strongly recommended that the materials remain sealed in the original packaging during transportation and storage. When material is required, the boxes should be opened in a clean environment and care taken to avoid contamination. Any remaining material should be re-sealed immediately and kept under standard conditions. Standard conditions would be defined as being sealed, dry, out of direct sunlight and at ambient temperature. Under standard conditions, Victrex materials may be stored in excess of 10 years.

### DRYING

Victrex materials are supplied nominally dry in their original packaging; however, they can absorb moisture from the atmosphere. In order to achieve optimum processing and performance, the pellets should be dried to give a moisture content of less than 0.02%.

Victrex materials can be easily dried in standard air circulating ovens and can be considered dry after 2-3 hours at temperatures between 150°C - 160°C. When drying in trays the pellet depth should be no more than 25mm. The drying process can be accelerated by the use of vacuum ovens or dehumidifying/desiccant dryers as depicted in Figure 1. Dehumidifying/desiccant dryers must be capable of maintaining a dew point or saturation temperature of -40°C.

In order to prevent cross-contamination of materials, it is recommended that dedicated equipment is used for Victrex materials. If this is not possible, or different materials are dried in ovens at the same time, then good housekeeping and sufficient segregation is advised.

**Figure 1: Drying of Victrex PEEK 450G in a desiccant dryer (dew point -40°C) at several temperatures**

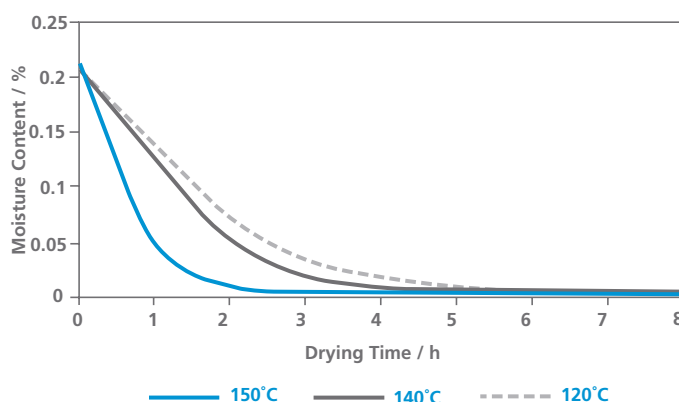

## REGRIND

It is common practice with most thermoplastic materials to optimise/maximise usage. This invariably means reworking ground sprues, runners and rejected parts. Victrex materials are suitable for rework in this way due to their excellent thermal stability when processed under recommended processing conditions. It is therefore possible to recover ground materials from unfilled grades without the adverse effect of thermal degradation. For fibre-filled grades, rework will result in shorter fibre lengths and a corresponding adverse effect on mechanical performance. General guidelines for the use of regrind are to restrict the maximum levels to 30% by weight for unfilled polymers and 10% by weight for filled compounds; however, it is recommended that this is validated by customers. It should also be noted that rework can introduce extraneous and cross contamination from other polymers and grinding equipment. Due to the high temperatures used for processing Victrex materials, contamination results in black specks which can have a significant impact on the quality of the parts produced. The use of dedicated regrind equipment is strongly recommended.

## THERMAL STABILITY

Thermal stability of Victrex materials may be broadly classified by polymer and by composition: PEEK, HT and ST have increasing melt points and processing temperatures, with associated decreasing thermal stability; a further reduction in stability is encountered with glass-fibre filled products.

Although it is preferable not to leave these products at elevated temperatures for extended periods of time, there may be situations where this is unavoidable; as a guideline therefore:

- For short stoppages during processing, the material can be maintained at a reduced temperature above its melting point without appreciable degradation. For PEEK and HT this correlates to approximately 1h/360°C or 30min/ 380°C respectively, with another 50% reduction in time when moulding glass fibre filled products. When moulding ST products, stoppages should not exceed much more than 5 to 10min, especially when processing glass fibre-filled ST 45GL30.
- For delays expected to last up to one or two hours, the temperature should be lowered to slightly below the material's melting point: 340°C for PEEK, and 370°C HT; ST –based products should not remain at temperature in the barrel for extended periods.
- For longer delays the barrel should be fully purged and thoroughly cleaned.

After any process interruption the barrel temperatures need to be returned to the recommended temperatures. The barrel must be purged with fresh product until the melt is clean. It is advisable to discard the first few mouldings. Product specific recommendations are available on product data sheets which are available from your local Victrex representative.

## RHEOLOGY AND PROCESSABILITY

Like most thermoplastic materials the melt viscosities of Victrex materials are temperature dependent and show shear thinning. A comparative plot of melt viscosity at a shear rate of 1000s<sup>-1</sup> for Victrex materials and a range of other engineering plastics is shown in Figure 2. Although Victrex materials have one of the highest processing temperatures, their melt viscosity is in the range of polycarbonate melts.

Victrex also has a range of high flow materials for thin wall mouldings with viscosities similar to those of PA materials.

**Figure 2: Shear viscosities at a shear rate of 1000 s<sup>-1</sup> at typical processing temperatures for a range of thermoplastics**

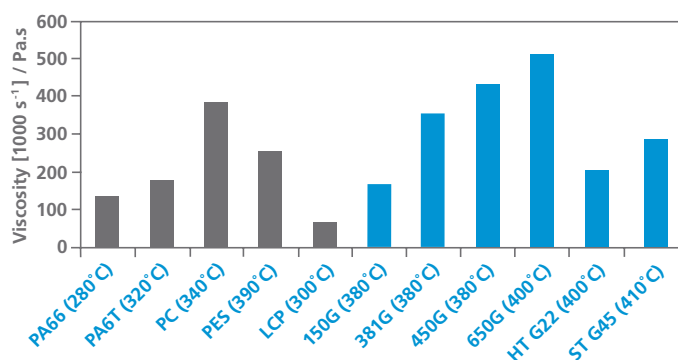

State of the art test equipment is used to measure shear viscosities.





High quality mouldings are achieved through accurate process control.

Materials based on PEEK 450 have higher viscosity than those based on PEEK 150 and PEEK 90. Blending Victrex polymers with glass or carbon fibre increases viscosity depending on filler type and content; the resulting flow length in a 1mm thick spiral flow tool is summed up for unfilled materials and 30% filled compounds in Figure 3.

**Figure 3: Spiral flow length for a range of Victrex materials at recommended processing conditions (cross section 1mm x 6mm)**

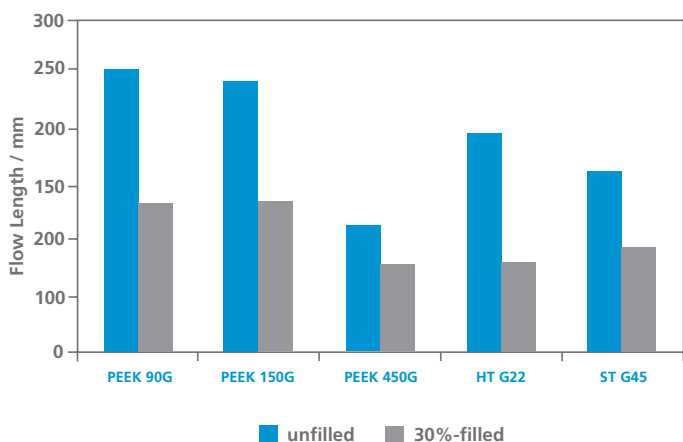

## PURGING

Victrex materials and compounds should ideally be processed on completely clean equipment. For injection moulders this will require removing the screw from the barrel for mechanical cleaning. If removal of the screw is not possible, then purging is essential. Suitable purge materials are those which are stable up to 380°C (with appropriate caution, these could include PES and PEI). Alternatively, there are commercially available purging compounds that are designed to be used at Victrex material processing temperatures.

### Start-up procedure

All traces of other polymers **MUST** be removed from the equipment before Victrex materials are processed. Due to the high temperatures used to process Victrex materials any cross-contamination from other polymers will result in degradation and black speck generation.

- Purging should take place at the processing temperature of the material to be removed.
- Purge is introduced until there is no visible trace of the material being removed.
- Cease feeding purge and allow the screw to empty.
- Set the barrel heaters to reach the required processing temperature of the Victrex material.
- When processing temperatures are achieved, feed the Victrex material into the screw and extrude until a clean melt is evident.

### Shut-down procedure

Victrex materials should be removed from processing equipment before other materials can be processed. This is also important if using equipment with nitride layers; if Victrex materials are allowed to solidify on the metal it can result in the nitride layer being peeled away.

- Empty the hopper and barrel of Victrex material.
- Introduce purge until there is no visible trace of the material being removed.
- Reduce the settings of all barrel zones to a stable temperature suitable for the purging material.
- Continue to feed purge until the actual barrel temperature is below 300°C.
- Cease feeding purge and allow the screw to empty.

## MACHINE DESIGN

Victrex materials can be readily processed on general-purpose reciprocating injection moulding machines providing the barrel heater bands are capable of high temperature processing. Best practice includes the use of ceramic heater bands and barrel blankets. When moulding components to tight tolerances, machines with an electric injection unit provide for more tightly controlled process than conventional hydraulic machines.

## MATERIALS OF CONSTRUCTION

The problem of machine wear is common to all engineering thermoplastics and can be particularly severe when injection moulding fibre-filled materials. To minimise wear, screws, dies and barrels should be hardened. The most common way of hardening tool steel is to coat with nitride. This technique provides the surface hardness necessary to resist excessive wear from the melt. Care must be taken to ensure that Victrex materials do not cool and solidify in contact with the nitride coating; the bond between the polymer and the nitride coating is often strong enough to lift the nitride layer from the steel substrate. The following steels have been used successfully for the construction of process equipment suitable for Victrex materials:

- D2 Tool Steel (martensitic chromium tool steel)
- WEXCO 777
- CPM-10V
- CPM-9V
- S32 219 (stainless steel)

Although not generally required, corrosion resistant and bi-metallic screws and barrels have proved satisfactory in service. Copper and copper alloys should be avoided because they can cause degradation at Victrex materials processing temperatures. The surface finish of metallic components which are in contact with molten polymer should be smooth and highly polished. Increasing the surface roughness of these components causes the melt to adhere locally to the metal, which increases residence time, increases the chance of black speck formation and disturbs polymer flow.

## BARREL HEATING

Cylinder heaters must be able to reach and maintain 400°C for moulding PEEK and its compounds, or 430°C for moulding HT and ST and their compounds. Most injection moulding machines are capable of reaching these temperatures without the need for modification. If modifications are required these are usually to upgrade heater bands and / or controllers. The preferred ceramic heater bands provide most consistent processing and shot-to-shot repeatability compared to mica heater bands. In addition, barrel blankets are recommended as they offer processing and cost saving benefits.

Thermal conduction along the screw and barrel to the hopper may reduce feed efficiency. To achieve correct hopper feeding, the feed throat should be maintained between 70°C and 100°C. Thermal control may be achieved by water cooling, but care must be taken to maintain the rear zone temperature.

## BARREL CAPACITY

As with all polymer processing, it is advisable to keep the residence time as short as possible. Ideally, the barrel capacity should be between 2 and 5 times the total shot weight including sprue and runners. If it is necessary to mould Victrex materials on a machine which has a larger number of shots in the barrel, then the temperatures may be reduced by 10°C to 20°C below the recommended temperature settings (see troubleshooting section). Care must be taken when lowering the temperatures for moulding HT and ST materials as they freeze off more readily at the nozzle.



The moulding machine should be the appropriate size for the parts that is being produced.

## NOZZLES AND SHUT-OFF SYSTEMS

The nozzle is in contact with the sprue-bushing for a high percentage of the total cycle time during normal operations, with the sprue-bushing having a considerably lower temperature than the melt and nozzle. Victrex materials have a sharp solidification point  $T_c$  and will freeze quickly if the melt temperature falls below  $T_c$ . Therefore, it is important to ensure that an adequately large heater covering the majority of the nozzle is fitted to prevent freeze off and cold slugging. Extended nozzles are not generally recommended for use with Victrex materials because of the increased risk of solidification and / or degradation in the nozzle.

At the recommended process temperatures, the viscosity of Victrex materials is generally high enough to allow an open nozzle system. Shut-off nozzles are not recommended because they frequently contain melt dead spots and restrict injection pressure. If excessive die drool is encountered, minor melt decompression can be employed, but adequate venting will be needed in the cavity.

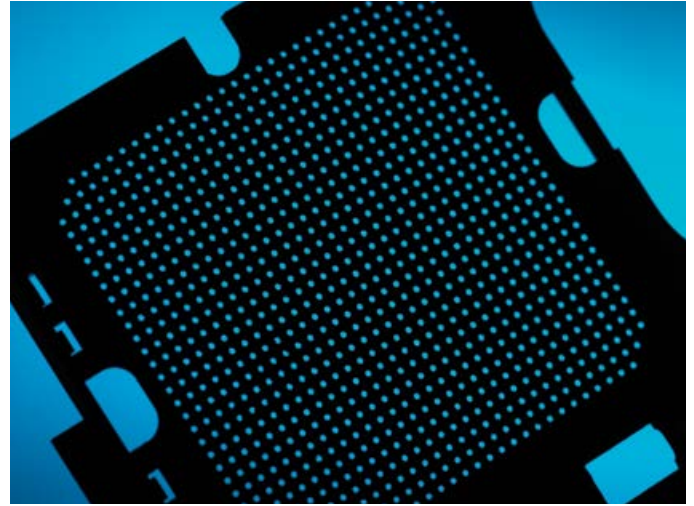

Flat parts with complicated geometries may be obtained with Victrex polymers despite their semicrystalline nature and their high processing temperatures.

## CLAMPING PRESSURE

The projected area of the moulding and runner determines the clamp force required to prevent the mould from opening under injection pressure. Injection pressures can exceed 2000 bar for thin walled components, particularly for reinforced Victrex materials.

## SCREWS

Most general purpose and nylon type screws are suitable for processing Victrex materials. Their appropriate length to diameter ( $L/D$ ) ratios are shown in Figure 4.

The minimum recommended  $L/D$  ratio screw is 16:1.  $L/D$  ratios between 18:1 and 24:1 are preferred. Long feed sections are required to prevent compaction of unmelted pellets in the compression section. The compression ratio should be between 2:1 and 3:1. Check rings must always be fitted to the screw tip to ensure development of a full and sustained injection pressure. Ring clearance should allow for an unrestricted flow of material on forward movement of the screw which typically corresponds to a 3mm clearance from the screw tip diameter for a medium size moulding machine.

Figure 4: Recommended screw types

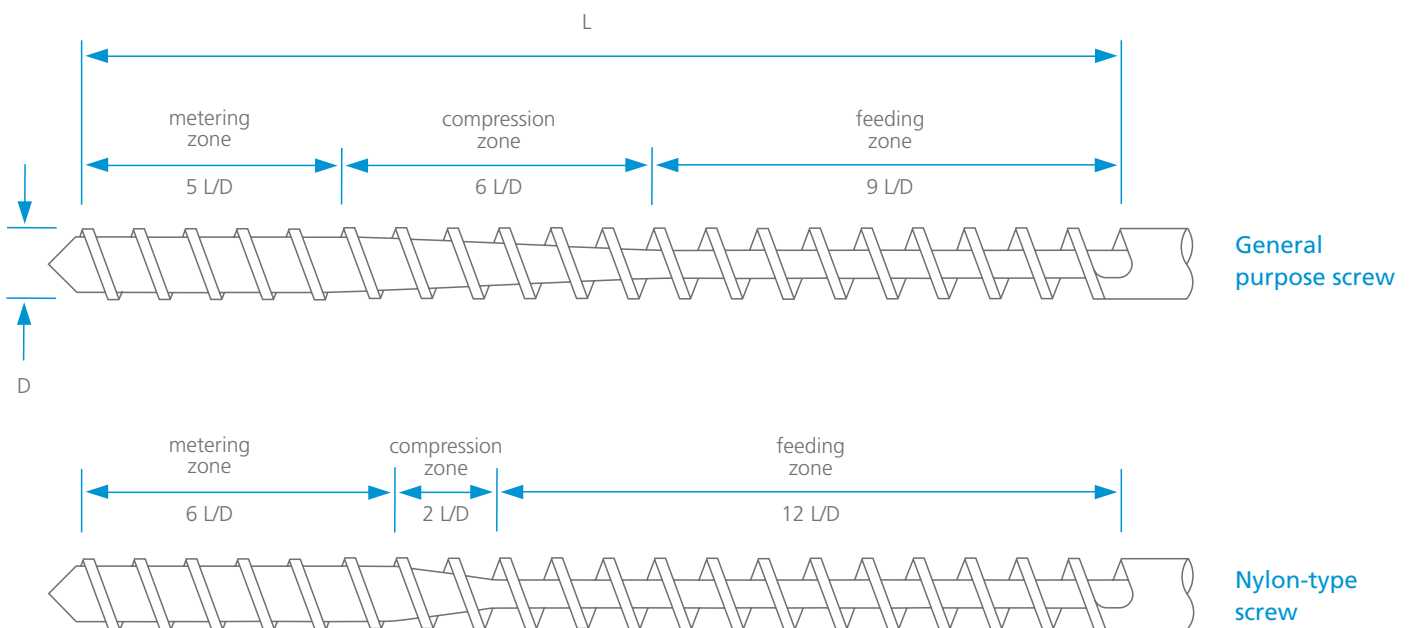



## MOULD DESIGN

Victrex materials can be readily injection moulded using standard tooling technologies. However, due to the high melt temperature ( $\approx 400^{\circ}\text{C}$ ) and high tool temperature ( $\approx 200^{\circ}\text{C}$ ) certain design criteria should be considered. These are listed below.

### MATERIALS OF CONSTRUCTION

Mould tooling should generally have hardness in the range of 52 - 56HRC. A good quality hot working steel commonly used for processing most Victrex materials is a BS BH13 with good high-temperature strength, excellent toughness and ductility and good machinability. It can be hardened to 54-56HRC. Moulds used for processing glass or carbon fibre-filled grades in low to medium volumes can be equipped with gate inserts made from BH13.

For moulds used to process glass or carbon fibre filled grades in long runs, tool steels such as BS BD3 or BD6 with hardness 56 – 60HRC may be considered.



Larger moulds will require more critical control on heating.

For prototyping or short running tools a BP20 has proven useful. It is also common practice is to use a BP20 bolster with a BH13 cavity and core.

**Table 1: Some frequently used tool steels**

BS	AISI	W.-No.	DIN	JIS	HRC
BD2	D2	1.2379	X155CrVMo121	SKD11	55-62
BH13	H13	1.2344	X40CrMoV5-1	SKD61	54-56
BD3/BD6	D3 ~ D6	1.2436	X210CrW12	SKD1	56-60
BP20	P20	1.2311	40CrMMo		50-53

### VENTING

It is important to provide sufficient venting for good filling and to prevent burning. Venting slots of  $8\mu\text{m}$  depth for easy flow PEEK 90G or 10 to  $15\mu\text{m}$  for standard grades can be incorporated without formation of burrs. Their location depends strongly on part design; simplest position would be in the mould parting plane or along ejector pins. If venting is still insufficient, the slot size may be further increased stepwise; employing sacrificial tabs may also be an option.

### HEATING

Moulds for Victrex materials may be equipped with electrical heaters or oil heating; high pressure water heating is an option but not commonly found for Victrex products due to high pressure requirements and associated safety concerns.

- Electrical heating is economical and relatively easy to integrate and service. Depending on its power rating, heat up time may be relatively short. Hot spotting is frequently observed; this heating method is best applied to small components.
- Oil heaters are more difficult to design and implement. Their distinct advantage is their ability to extract heat which may be required for moulding larger shot sizes or using tools with large/deep cores.
- The combination of both may be considered for rapid heating combined with maintaining a controlled temperature distribution over time.

The use of insulation boards between the mould and the machine platen is strongly advised. It is also common practice to pack the tool with thermal insulation for a uniform temperature distribution and for economic reasons. For oil heating it is also recommended to use large diameter insulated flow lines which are as short as possible, heat losses as high as  $40^{\circ}\text{C}$  are common. Always check that the temperature of the tool surface is at least  $170^{\circ}\text{C}$  when setting up the machine and the process: with oil heating, losses through the flow lines frequently mean that the set temperature of the heater may be considerably higher than the actual temperature achieved at the tool surface.

## SPRUES

Sprues should be at least 4mm thick and as short as possible with a draft angle of at least 2°. The use of a generously dimensioned cold slug-well is recommended. Larger diameter sprues have been shown to aid filling complex moulds. For direct gating of larger sized components the sprue should be 1 to 1.5 times the component thickness.

## GATING

The size and style of gating appropriate for a mould will depend on part volume, number of cavities and component geometry. Victrex materials are semi-crystalline thermoplastics and as such have higher shrinkage than amorphous polymers. To reduce shrinkage and excessive stress build up, gates should be made as large as possible. Gate size is a function of component thickness and should be a minimum 1mm for unfilled materials and 2mm for compounds, or 2/3 the component wall-thickness for thick parts. Sprue gates should be 1 to 1.5 times the thickness of the moulding. Most gate designs are suitable for moulding Victrex materials. Tab, side or fan gates are most common. Submarine or tunnel gates should only be used for thin wall or small parts.

The main rule in designing a gate for Victrex materials to minimise sink marks / voids is that the gates should be as large as possible to maintain the material flow for as long as possible (2/3 of maximum section thickness is recommended).

## HOT RUNNERS

Victrex materials can be processed in hot runner systems. In most cases, best processing results are achieved using externally heated manifolds feeding into sprue style nozzle tips as this provides the widest and most forgiving processing window; torpedo style tips tend to be problematic due to the heat flux to the surrounding mould cavity steel. In addition, one common approach is to utilize a hot runner system feeding a small cold runner system for materials savings and providing ease of processing. Hot sprue bushings can also be used as they tend to widen the processing window in terms of increasing secondary hold pressure for thick walled parts.

## MACHINE SETTINGS

### TEMPERATURE SETTINGS

The operating conditions for each individual injection moulding machine and tool will depend on many variables. Figure 5 shows a principal overview of recommended temperature settings to start with when moulding Victrex materials.

- The hopper needs to be maintained at relatively low temperature to ensure pellets feed properly into the screw.
- After the hopper, heat is required to allow pellets to melt before reaching the compression zone.
- Figure 5 illustrates typical barrel temperature profiles for moulding unfilled PEEK, HT and ST; they are shifted upwards due to their increasingly higher melt points.
- Higher viscosity compounds of these polymers require increased barrel temperatures (typically between 10°C and 20°C depending on filler type and filler level).
- Recommended tool temperatures to obtain crystalline components moulded with PEEK, HT and ST are 170°C, 190°C and 200°C respectively. Higher tool temperatures may be useful to assist filling of the cavity, especially for filled grades or to increase dimensional stability of components exposed to higher service temperatures. This increases cycle time, but will not damage the polymer.

Individual product data sheets may be requested through your local Victrex representative, or downloaded from [www.victrex.com](http://www.victrex.com), listing a combination of relevant material properties and recommended machine settings.

**Figure 5: Typical temperature settings for processing unfilled Victrex materials**

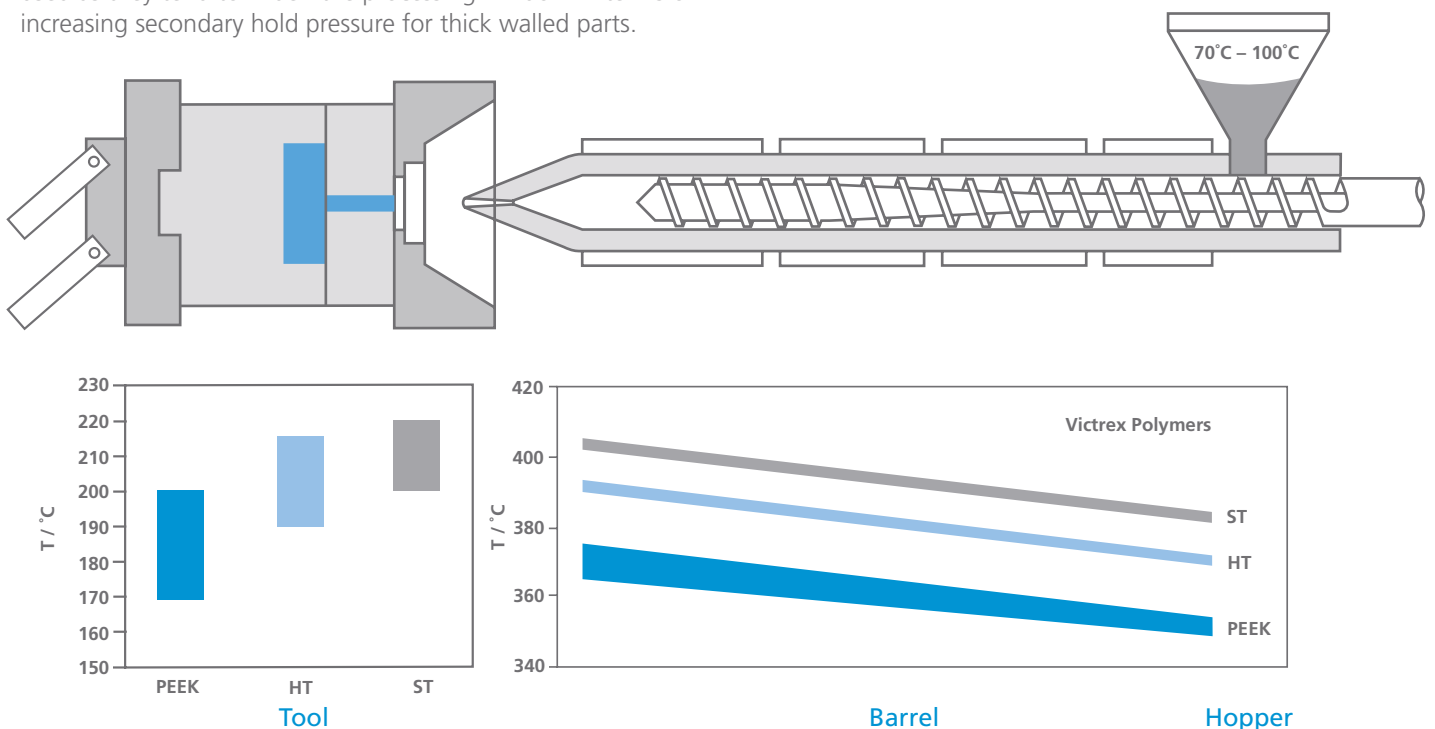

## SCREW SPEED

The excellent thermal stability of Victrex polymers allows for a broad range of screw speeds without damaging the polymer. Screw tip velocities between 5 and 10m/min are recommended for processing unfilled Victrex materials; the correlation to screw speed in rpm is shown in Figure 6. For Victrex compounds it is recommended to remain at the lower end of 5m/min; shear effects may cause excessive fibre scission at higher screw speeds, which may impair mechanical performance.

**Figure 6: Screw speeds in m/min and rpm as function of screw diameter**

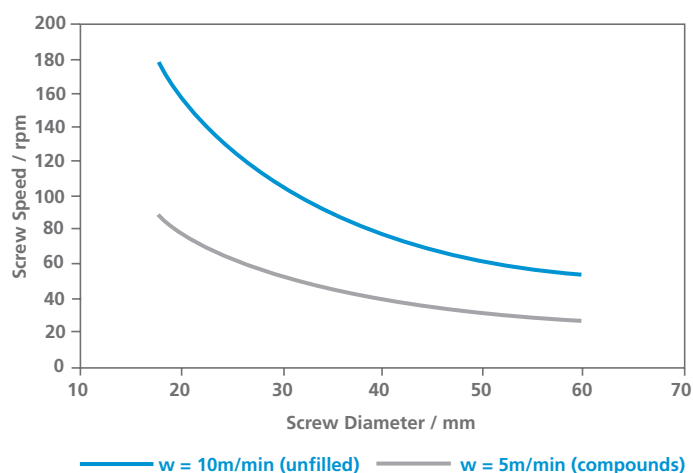

Both material properties and moulding conditions have a significant influence on mould shrinkage.

## BACK PRESSURE

To homogeneously plasticise Victrex materials a back pressure of  $\approx 20$  to 50bar is suitable. Fibre-filled compounds should be processed at lower back pressures to reduce fibre breakage.

## INJECTION PRESSURE

The injection pressure is system dependent and can be estimated using process simulation software. Depending on design, melt temperature, injection speed and tool temperature, pressures up to 2000bar may be encountered; in some cases these can be managed by increasing temperatures (increasing gate freeze off time), reducing injection speed and/or increasing the flow path cross section (sprue, runner, gate).

## HOLDING PRESSURE

Holding pressures are typically lower than injection pressures and must be maintained throughout the gate freeze-off time to avoid sink marks and voids.

## SHRINKAGE

Thermoplastic materials shrink while cooling in the mould; for Victrex materials this is caused by thermal contraction and the development of crystalline regions. Mould shrinkage is better viewed as a technology property than a simple material property since moulding conditions have a significant influence: increasing injection and holding pressure and holding time will generally decrease shrinkage, whereas elevated barrel and tool temperature typically increase mould shrinkage. Part geometry and dimensions as well as flow characteristics (gating) will further influence its value.

Shrinkage was evaluated on fan gated plaques moulded using recommended moulding conditions. Results can be classified as shown in Table 2 for 2 and 6mm thick mouldings. Adding reinforcing fillers with a high ratio generally decreases shrinkage, also giving rise to significant non-isotropic behaviour. This must be viewed with care when cutting a tool, which should always be on the metal-safe side.

**Table 2: Typical shrinkage values of fan-gated plaques moulded under recommended processing conditions**

Grade	Shrinkage 2mm thickness		Shrinkage 6mm thickness	
	With flow (%)	Across flow (%)	With flow (%)	Across flow (%)
Unfilled grades	1.0	1.3	1.7	1.8
GL30 filled grades	0.3	0.9	0.5	0.9
CA30 filled grades	0.0	0.6	0.1	0.6
FC30 wear grades	0.2	0.6	0.4	0.7

## TOLERANCES

Typical tolerances are approximately 0.05% with standard moulding conditions. Dimensional tolerances depend on many factors, including part and mould design and specific processing conditions. Table 3 shows values determined on 2 and 6mm thick plaques moulded with a generously dimensioned fan gate.

**Table 3: Dimensional tolerances for Victrex materials**

Grade	Tolerance 2mm thickness		Tolerance 6mm thickness	
	With flow (%)	Across flow (%)	With flow (%)	Across flow (%)
Unfilled grades	0.02	0.03	0.05	0.07
GL30 filled grades	0.02	0.02	0.07	0.08
CA30 filled grades	0.02	0.04	0.05	0.09
FC30 wear grades	0.02	0.03	0.04	0.04

## METAL INSERTS

Overmoulding cold metal inserts leads to reduced crystallinity within the contacting material layers. It is therefore recommended to pre-heat metal inserts to mould temperature which improves weld line strength, reduces stress cracking potential due to differential shrinkage and ensures that standard levels of crystallinity are obtained.

## CYCLE TIME / COOLING TIME

In many cases, Victrex materials are specified in applications with tight tolerances or in structural components; it is therefore important to produce dimensionally stable parts with no sink marks or voids. The component quality is therefore paramount over the overall cycle time and is greatly impacted by the cooling time.

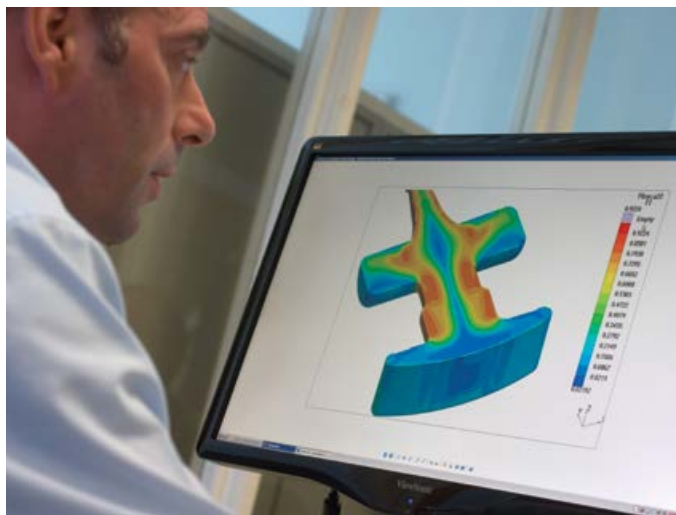

Process simulation allows for optimal placement of gates.

The estimated cooling time versus wall thickness for various Victrex materials is shown in Figure 7. Cooling time depends on machine settings and material characteristic as well as mould design. By improving the ejection system, such as the number of ejector pins, their size and location, cooling time can be reduced by approximately 15% for unfilled materials and ejected at 10°C higher temperature than indicated in Figure 7.

**Figure 7: Estimated cooling time as a function of wall thickness at a tool temperature of 180°C**

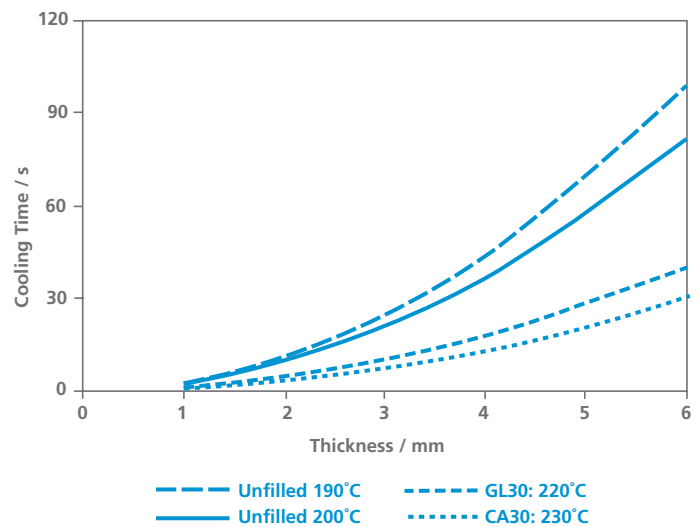

## PROCESS SIMULATION

Process simulation using numerical calculations is strongly recommended prior to cutting a mould. The simulation should be used to determine gate locations to ensure a part fills with a pressure that is well within the machine capabilities. The simulation should be used to place gates to ensure balanced flow, minimise knit lines and determine where venting is needed. Process simulation is also a powerful tool to troubleshoot moulding issues and part performance issues.



## ADVANCED MOULDING TECHNOLOGIES

Victrex materials are semi-crystalline thermoplastics and should as such render themselves being processable by any technology suitable for other semi-crystalline thermoplastics. A number of technologies have been investigated with PEEK polymers, including gas-assisted injection moulding, foaming, blow moulding, micro injection moulding, as well as using induction heating for tool surfaces. Specific details can be obtained from your local Victrex representative.

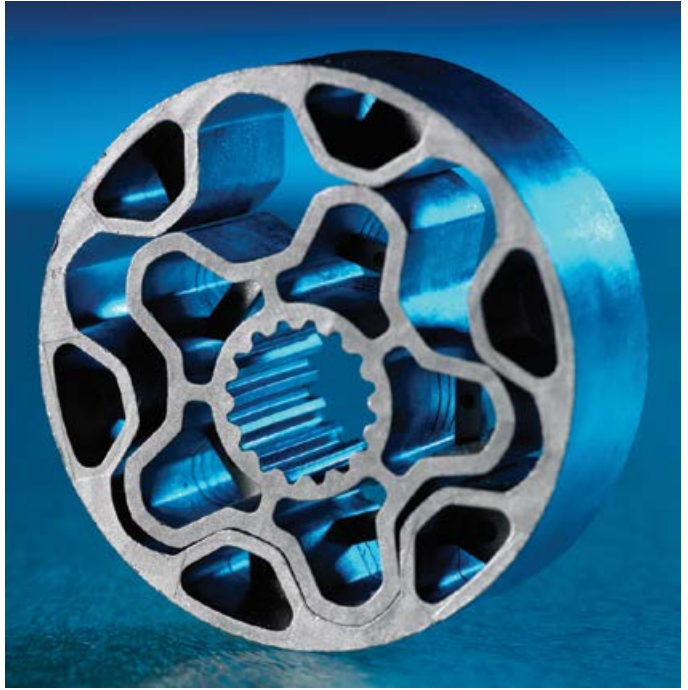

Parts with very tight tolerances can be achieved by injection moulding.

## TECHNICAL SUPPORT

Victrex Polymer Solutions is uniquely committed to polyaryletherketone products and is well-placed to meet your full range of quality, technical and supply security requirements. In today's competitive environment, working with a leading supplier with advanced technologies and most in-depth and responsive technical services available can be critical for success.

*If you would like more information or assistance, please contact your local Victrex Polymer Solutions representative or visit us at [www.victrex.com](http://www.victrex.com).*

## TROUBLESHOOTING

Historically, the most common processing issues can be related to insufficient mould temperature, gates that are designed too small for the part to be produced and contamination caused by insufficient purging. The following tables give an overview of frequently encountered defects, their likely cause, and recommendations to their rectification.

### Dark brown / transparent edges or dark colour throughout component (visible in natural coloured grades only):

Possible cause	Remedy
Low tool temperature (amorphous regions)	Increase tool temperature In case of patchy parts: check for cold spots in cavity
Thermal degradation	Decrease barrel temperatures

### Black specks (visible in natural coloured grades only):

Possible cause	Remedy
Cross contamination	Equipment for handling and drying of pellets must be spotlessly clean Check grinder / regrind if used
Insufficient purge prior to moulding Victrex materials	Thoroughly purge equipment as per Victrex recommendations Extract screw and use brushes for cleaning of screw and barrel Investigate melt flow areas for dead spots or damaged surfaces
Barrel and nozzle temperatures too high	Reduce barrel and nozzle temperatures
Residence time too long	Better match between shot size and equipment size

### Short mouldings:

Possible cause	Remedy
Insufficient material injected	Increase shot size
Inadequate flow of melt	Increase injection pressure Increase barrel temperatures Increase tool temperatures Increase injection speed Increase gates, sprues or runner size

### Short mouldings: (continued)

Possible cause	Remedy
Incorrect design	Increase gates, sprues or runner design Change position of gate
Blocked or absent venting	Increase venting
Incorrect material choice	Choose grade with lower melt viscosity
Leakage in plasticising unit	Check for wear in screw, barrel, check rings

### Brittle mouldings:

Possible cause	Remedy
Overheating in the barrel	Reduce barrel temperatures Reduce cycle time Decrease screw speed
Moulded-in stresses	Increase barrel temperatures Reduce injection pressure Increase cycle time Increase tool temperature Increase gates, sprues or runner size Increase barrel temperatures
Weld lines	Increase injection speed Increase tool temperatures Change gate design or position Improve venting
Jetting	Reduce injection speed Change position and / or type of gates

### Cold slug in polymer:

Possible cause	Remedy
Material freezing in the nozzle	Add cold slug well Check nozzle heater covers Employ decompression Use a sprue break
nozzle completely	

### Voids and surface sinking:

Possible cause	Remedy
Insufficient time or pressure in holding phase	Increase injection pressure Increase holding time / pressure Reduce barrel temperature
Incorrect tool design	Increase gates, sprues or runner size

### Poor surface finish:

Possible cause	Remedy
<b>Streaking:</b>	
Overheated material	Reduce barrel and nozzle temperature Reduce residence time Reduce injection speed Reduce screw speed
Damp material	Dry material
Dead spots in barrel	Streamline barrel and nozzle Clean screw, barrel and nozzle Check for damage, pitting, etc
<b>Surface frosting (reinforced grades):</b>	
Insufficient injection speed	Increase injection speed Increase barrel temperature
Tool temperature too low	Increase tool temperature
Over-shearing of the melt	Decrease screw speed

### Burn marks:

Possible cause	Remedy
Air trapped in cavity	Reduce injection pressure Reduce injection speed Check venting is not blocked Improve venting Change gate position, size or type

### Flashing or mould opening:

Possible cause	Remedy
Inadequate locking force	Reduce injection pressure Reduce injection speed Reduce barrel temperature (balance needed: increases viscosity, but also pressure) Reduce tool temperature Reduce speed setting Increase locking force or clamp tonnage
Incorrect mating or bending of the tool	Regrind and realign the mating surfaces Install heavy backing plates Check for foreign matter between the plates
Insufficient pillar support	Add support pillars

### Warping or distortion:

Possible cause	Remedy
Temperature difference in the tool	Adjust temperature so it is the same on both halves of the mould
Lack of section symmetry	Consider re-design of cavity, runners, and gates Use a temperature differential between the two halves of the mould to compensate
Early ejection	Use a cooling fixture or jig Increase cooling time Reduce tool temperature
Orientation of fibres in material	Change gate position Reduce injection speeds
Insufficient rigidity	Change design of components (e.g. add ribs, etc.) Increase section thickness Consider use of fibre reinforced grade Review ejector system (more / larger pins)

### Excessive shrinkage:

Possible cause	Remedy
Processing conditions	Reduce tool temperature Increase injection pressure Increase holding time / pressure
Gate too small	Increase gate size

### Poor component release:

Possible cause	Remedy
Insufficient component rigidity	Increase cooling time Decrease tool temperature
Insufficient draft angle	Increase draft angle
Inadequate ejector system	Increase cross sectional area of ejector pins by using more pins or increasing their dimensions
Inadequate tool surface finish	Line polish in direction of ejection Large surface area components may need venting to avoid vacuum build up

Victrex is an innovative world leader in high performance polymer solutions with products sold under the brand names of VICTREX® PEEK, VICOTE® Coatings, APTIV® film and VICTREX Pipes™. With production facilities in the UK backed by sales and distribution centers serving more than 30 countries worldwide, our global sales and technical support services work hand-in-hand with OEMs, designers and processors offering assistance in the areas of processing, design and application development to help them achieve new levels of cost savings, quality, and performance.

[www.victrex.com](http://www.victrex.com)

#### World Headquarters

Victrex plc  
Hillhouse International  
Thornton Cleveleys  
Lancashire  
FY5 4QD  
United Kingdom  
TEL +44 (0)1253 897700  
FAX +44 (0)1253 897701  
MAIL [victrexplc@victrex.com](mailto:victrexplc@victrex.com)

#### Americas

Victrex USA Inc  
300 Conshohocken State Road  
Suite 120  
West Conshohocken  
PA 19428  
USA  
TEL +1 800-VICTREX  
TEL +1 484-342-6001  
FAX +1 484-342-6002  
MAIL [americas@victrex.com](mailto:americas@victrex.com)

#### Europe

Victrex Europa GmbH  
Langgasse 16  
65719 Hofheim/Ts.  
Germany  
TEL +49 (0)6192 96490  
FAX +49 (0)6192 964948  
MAIL [customerservice@victrex.com](mailto:customerservice@victrex.com)

#### Japan

Victrex Japan Inc  
Mita Kokusai Building Annex  
4-28, Mita 1-chome  
Minato-ku  
Tokyo 108-0073  
Japan  
TEL +81 (0)3 5427 4650  
FAX +81 (0)3 5427 4651  
MAIL [japansales@victrex.com](mailto:japansales@victrex.com)

#### Asia Pacific

Victrex High Performance  
Materials (Shanghai) Co Ltd  
Part B Building G  
No. 1688 Zhuanxing Road  
Xinzhuan Industry Park  
Shanghai 201108  
China  
TEL +86 (0)21-6113 6900  
FAX +86 (0)21-6113 6901  
MAIL [scsales@victrex.com](mailto:scsales@victrex.com)

© Victrex plc March 2016

Victrex plc believes that the information contained in this brochure is an accurate description of the typical characteristics and/or uses of the product or products, but it is the customer's responsibility to thoroughly test the product in each specific application to determine its performance, efficacy and safety for each end-use product, device or other application. Suggestions of uses should not be taken as inducements to infringe any particular patent. The information and data contained herein are based on information we believe reliable. Mention of a product in this documentation is not a guarantee of availability. Victrex plc reserves the right to modify products, specifications and/or packaging as part of a continuous program of product development. VICTREX® is a registered trademark of Victrex manufacturing limited. VICTREX pipes™ is a trademark of Victrex manufacturing limited. PEEK-ESD™, HT™, ST™ and WG™ are trademarks of Victrex plc. VICOTE® and APTIV® are registered trademarks of Victrex plc. Victrex plc makes no warranties, express or implied, including, without limitation, a warranty of fitness for a particular purpose or of intellectual property non-infringement, including, but not limited to patent non-infringement, which are expressly disclaimed, whether express or implied, in fact or by law. Further, Victrex plc makes no warranty to your customers or agents, and has not authorized anyone to make any representation or warranty other than as provided above. Victrex plc shall in no event be liable for any general, indirect, special, consequential, punitive, incidental or similar damages, including without limitation, damages for harm to business, lost profits or lost savings, even if Victrex has been advised of the possibility of such damages, regardless of the form of action.

